

# A QUANTITATIVE ANALYSIS OF HANDS-FREE SPEECH ENHANCEMENT USING REAL AUTOMOBILE DATA

Mahdi N Ali, Ph.D., Hyundai-Kia America Technical Center, Inc.



# OUTLINES

- Introduction
  - Background
  - Objective
- Experiments Setup & Data Collection
- Noise Reduction Techniques for Speech Processing
- Spectral Subtraction & Wiener Filtering Techniques
- Test Results Discussions & Analysis
- Conclusion

# BACKGROUND & MOTIVATION

- Bluetooth voice quality in vehicles continues to pose a concern, especially in small vehicles
- Different types of noise resulting from vehicular dynamics and from the environments around the driver contribute to the poor audio quality.
- Vehicle background noise is a major factor in audio poor quality, which is caused by HVAC fan noise, engine noise, wind noise, sunroof/window noise, raining noise, turn signal indicator noise, road noise such as pot holes, speed bumps, etc.

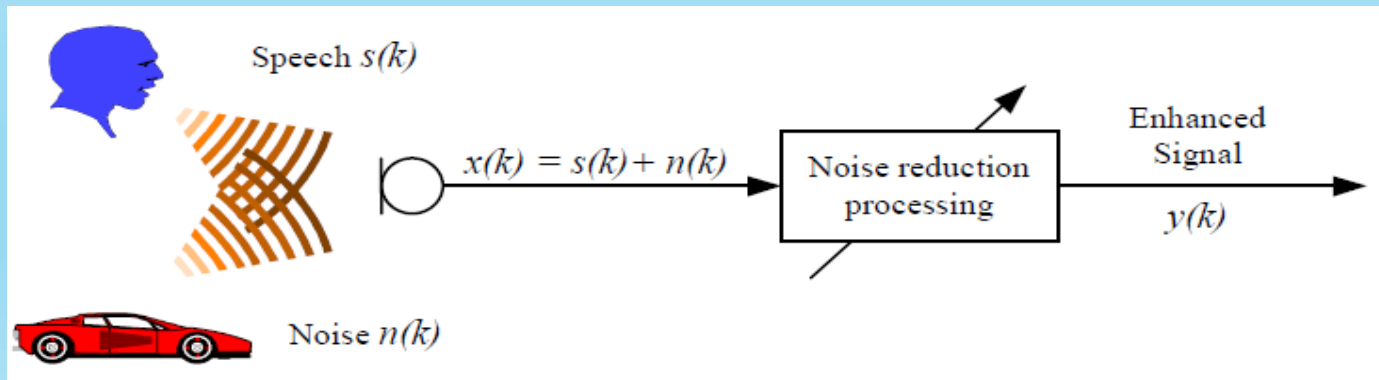

# OBJECTIVES

- The purpose of this research is to develop & implement algorithms to filter out vehicular background noise in order to enhance Bluetooth audio quality
- Compare the performance of two common filtering techniques operating on noisy speech recorded in real time automobiles travelling at various speeds. The filters are Spectral Subtraction (SS) and Wiener Filtering (WF)
- Compare the performance of these techniques to the embedded technique in 3 different vehicles
- Analyze the performance of the techniques objectively

# SCOPE OF THE RESEARCH

- The focus is to analyze the noise reduction techniques, which can be implemented in the Voice Communication Package (VCP)

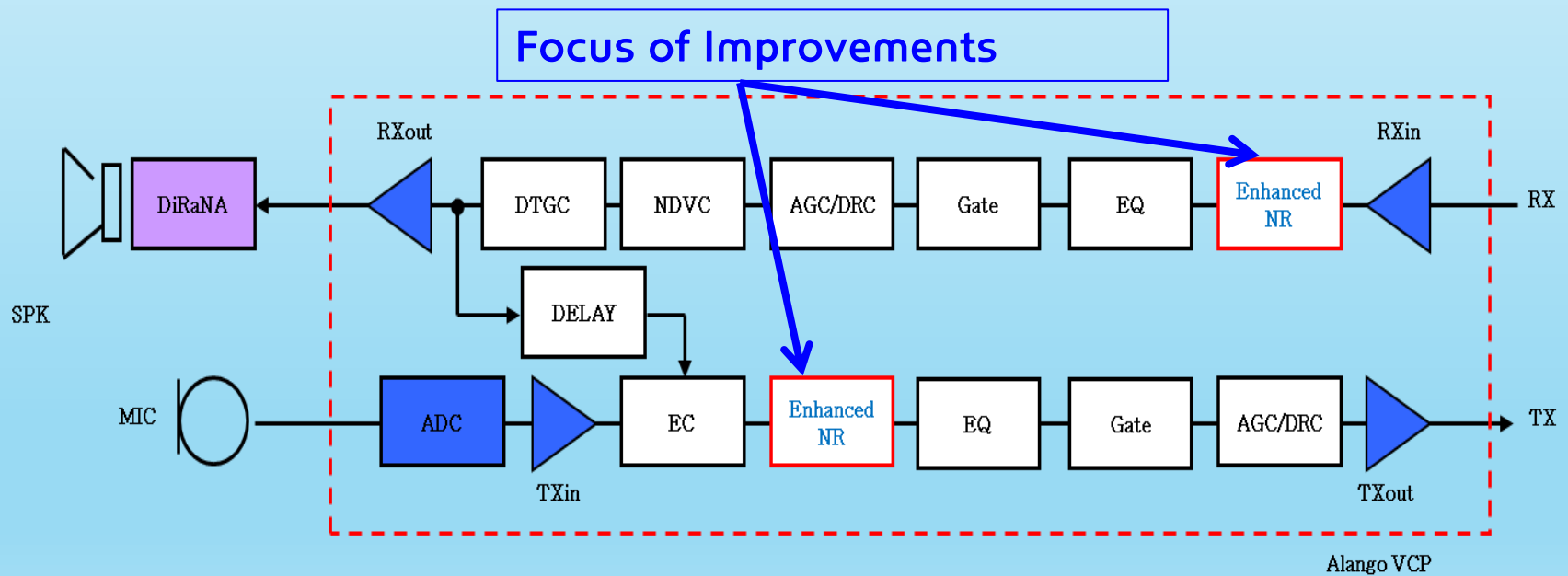

# DATA COLLECTION

- Three different vehicles were used to collect data
- The different settings included varying car speeds (e.g., 0 mph, 40 mph, 70 mph), varying fan power, and window positions settings. The study was carried out using three different car models. The filtered signals were compared in the time and frequency domains

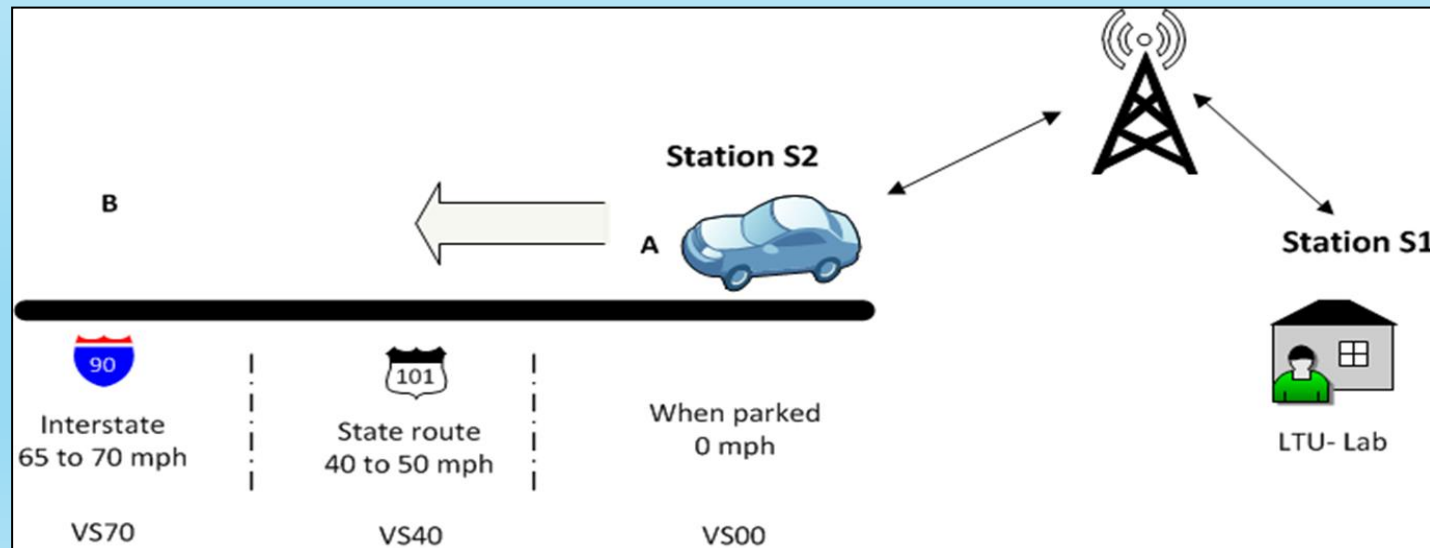

# CABIN NOISE ANALYSIS

Red : Velocity = 0 mph  
Green : Velocity = 40 mph  
Blue : Velocity = 70 mph

Probability  
Density  
Function

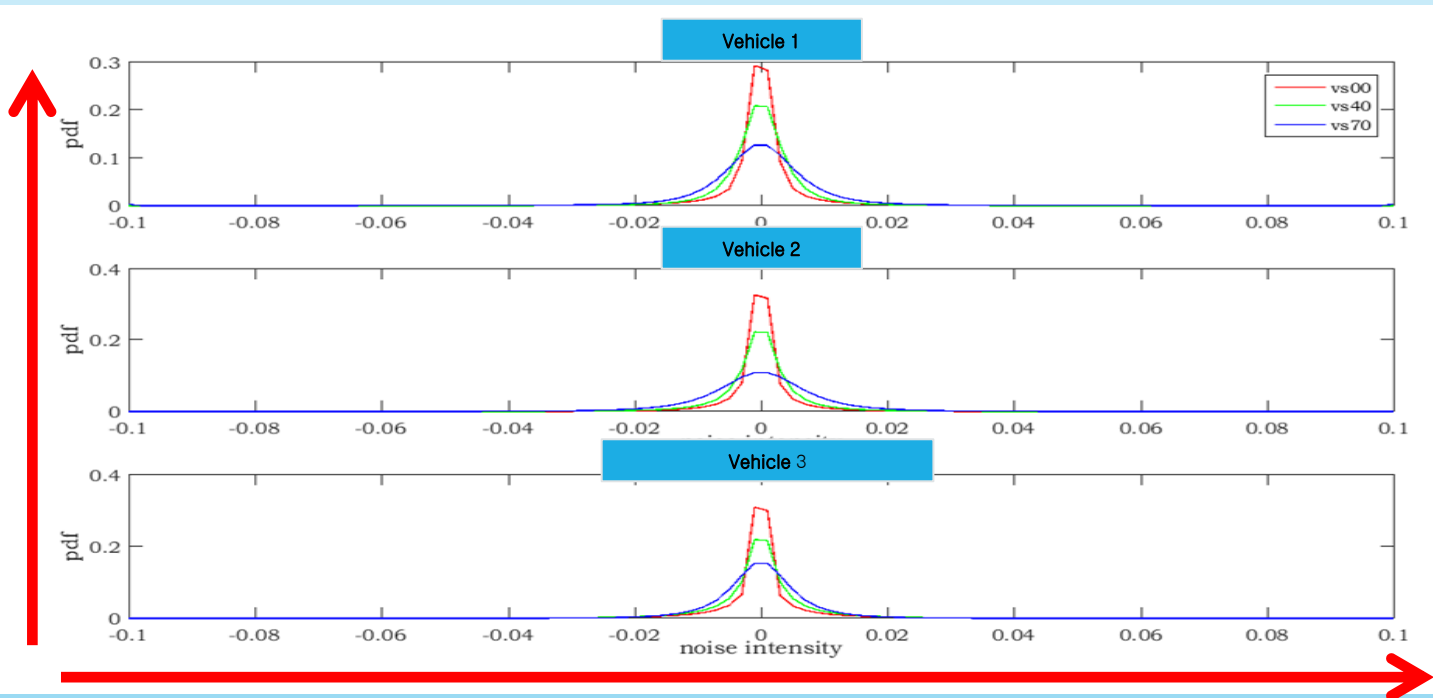

Noise Intensity

# SPEECH ENHANCEMENT NOISE REDUCTION TECHNIQUES

- Several noise reductions for speech enhancements exist
- In this study, we focused on the following techniques:
  - **Spectral Subtraction Algorithms (SS).** We used MMSE\_SPZC\_U, which is Minimum Mean Squared Error Spectrum Power estimator based on Zero Cross-terms assumptions, and the “U” term means that MMSE-SPZC estimator incorporates a-priori SNR Uncertainty
  - **Wiener Filtering (WF)**



# SPECTRAL SUBTRACTION USING MMSE-SPZC-U

- MMSE-SPZC-U - SPZC-U stands for Soft masking by incorporating a priori SNR Uncertainty proves to be one of the most promising methods in speech enhancement using SS
- Noise Estimation using Minima Controlled Recursive Averaging (MCRA)
  - Efficient local minima tracking
  - Computationally efficient; quick.

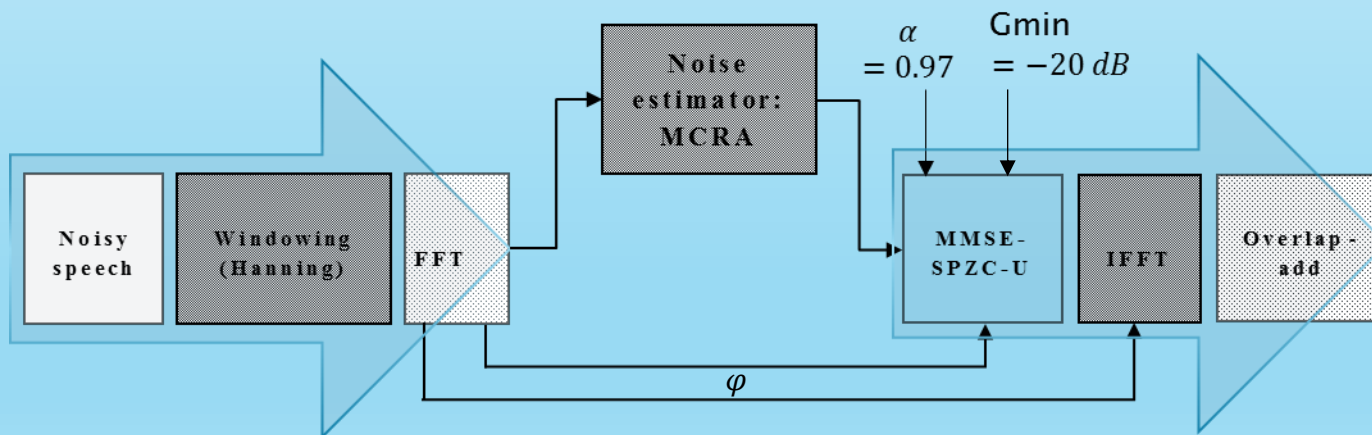

## WIENER FILTER OVERVIEW

- Wiener filter is a popular and fundamental filter proposed for speech enhancement
- Wiener filter is the optimal stationary linear filter
- Lots of research done on stationary noise
- Limited in-vehicle dynamic noise research done

# WIENER FILTER FLOWCHART

$$\hat{SNR}_{post}^t(\omega) = \frac{P_y(\omega)}{P_n^t(\omega)}$$

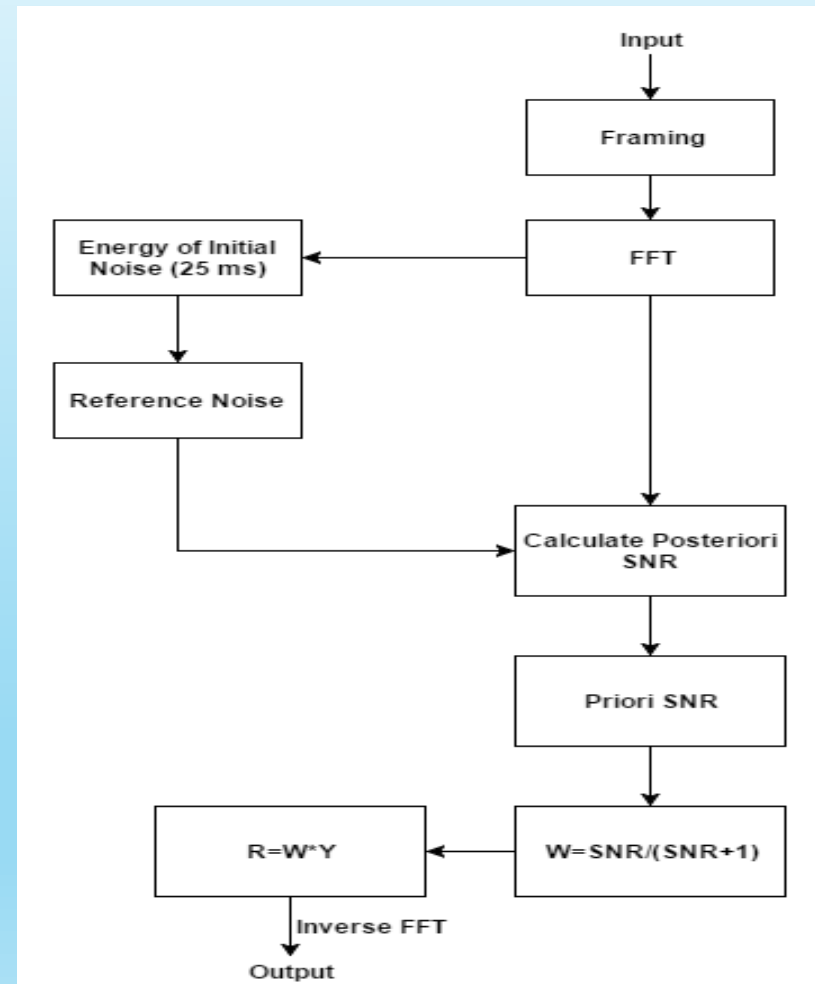

# WIENER FILTER: WITH FIRST-IN FIRST-OUT “FIFO”

- A noise detection process can detect noise and provide an estimate of real-time noise for the Wiener filter
- First In First Out (FIFO) Noise estimator
  - Estimate the power spectrum of background noise

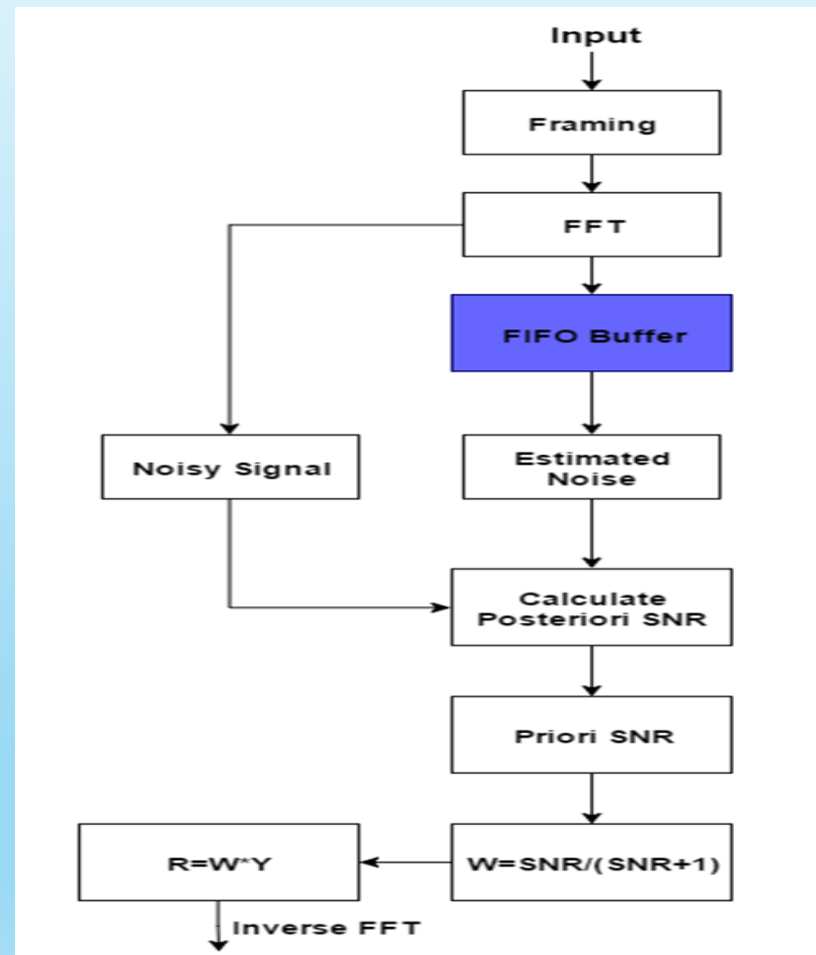

# OBJECTIVE ANALYSIS OF SPECTRAL SUBTRACTION AND WIENER TECHNIQUES

Performance comparison, in terms of PESQ (Perceptual Evaluation of Speech Quality) scores, between the two estimators tested on real Car noise. (Higher PESQ score = better sound quality)

Estimators	Vs = 70 mph Fan is 8/8 (max power)	Vs = 40 mph Windows are 10 % opened	Vs = 40 mph Fan is 5/8	Sum
MMSE-SPZC-U	2.15	2.62	3.00	7.77
Wiener filter	1.53	1.87	1.99	5.39

# OBJECTIVE ANALYSIS OF SPECTRAL SUBTRACTION AND WIENER TECHNIQUES

Performance comparison, in terms of WSS (Weighted Spectral Slope) scores, between the two estimators tested on real Car noise. (Lower WSS score = better sound quality)

Estimators	Vs = 70 mph Fan is 8/8 (max power)	Vs = 40 mph Windows are 10 % opened	Vs = 40 mph Fan is 5/8	Sum
MMSE-SPZC-U	108	85	64	257
Wiener filter	115	99	86	300

# POWER SPECTRAL DENSITY (PSD) ANALYSIS

PSD of the original noisy signal before and after filtration using the vehicle built-in filter and SS. ( $V_s = 40$  mph; Windows are 10% opened).

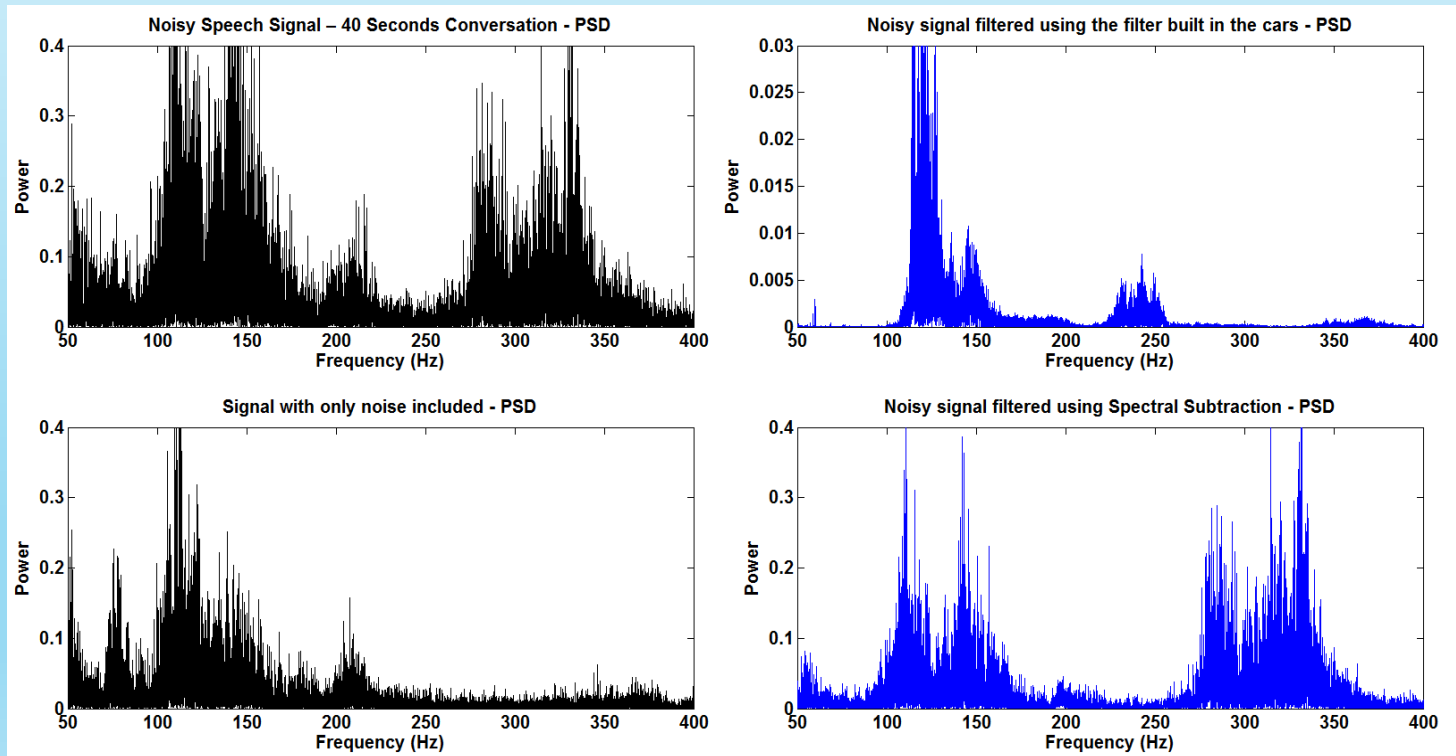

# POWER SPECTRAL DENSITY (PSD) ANALYSIS

PSD of the original noisy signal before and after filtration using the vehicle built-in filter and SS. ( $V_s = 40$  mph; Fan at 5/8).

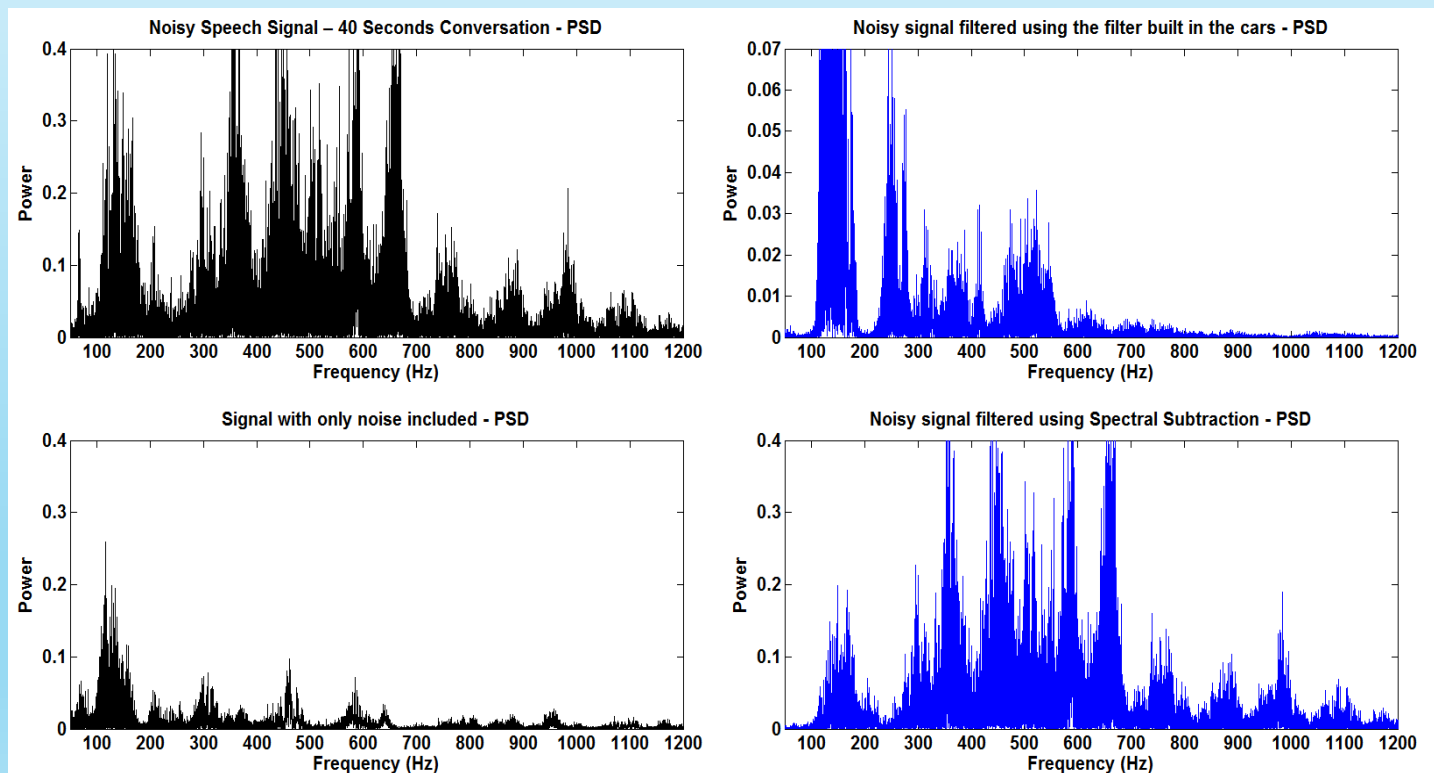



# POWER SPECTRAL DENSITY (PSD) ANALYSIS

PSD of the original noisy signal before and after filtration using the vehicle built-in filter and SS. ( $V_s = 40$  mph; Fan at max speed).

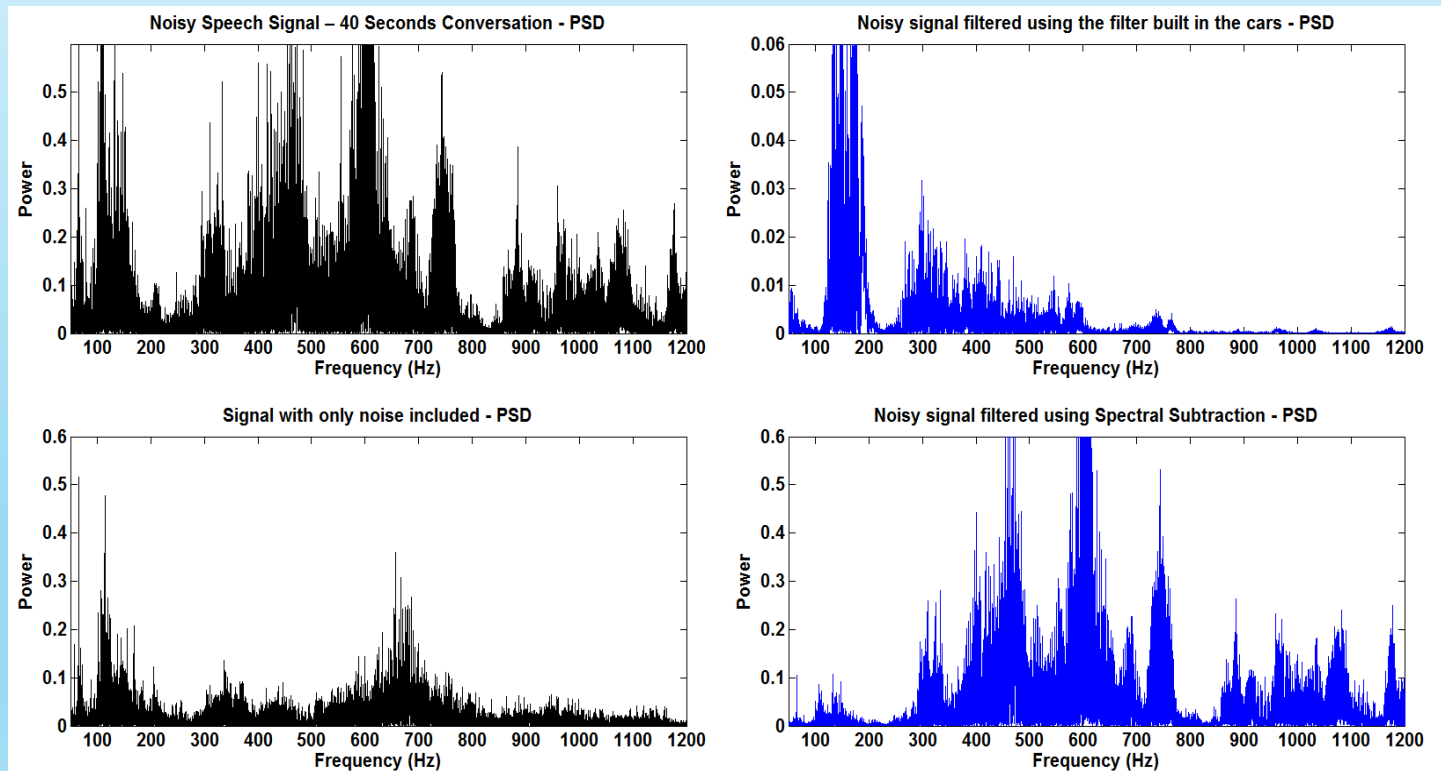

# CONCLUSION

- Any noise mitigation technology for Bluetooth audio quality improvements must take into account the vehicle speed for effective noise cancellation and removal
- Filtering techniques in this study used real data from 3 different vehicles
- Spectral Subtraction proved superiority over Wiener filtering
- It delivers good speech quality in terms of speech intelligibility and noise reduction
- It is an excellent one-channel noise filter for automotive environment



# QUESTIONS??