



IEEE International Conference
on Image Processing
25-28 October 2020, United Arab Emirates



Improving Detection and Recognition of Degraded Faces by Discriminative Feature Restoration Using GAN



Soumya Shubhra Ghosh • Yang Hua
Sankha Subhra Mukherjee • Neil Robertson

Introduction

- Face detection and recognition from low-quality images common problem.
- It is quite challenging but highly demanded in real-world applications.
- Several effective solutions have been proposed for face recognition.
- Their performance drops significantly with degraded images.

Drawbacks of Previous Methods

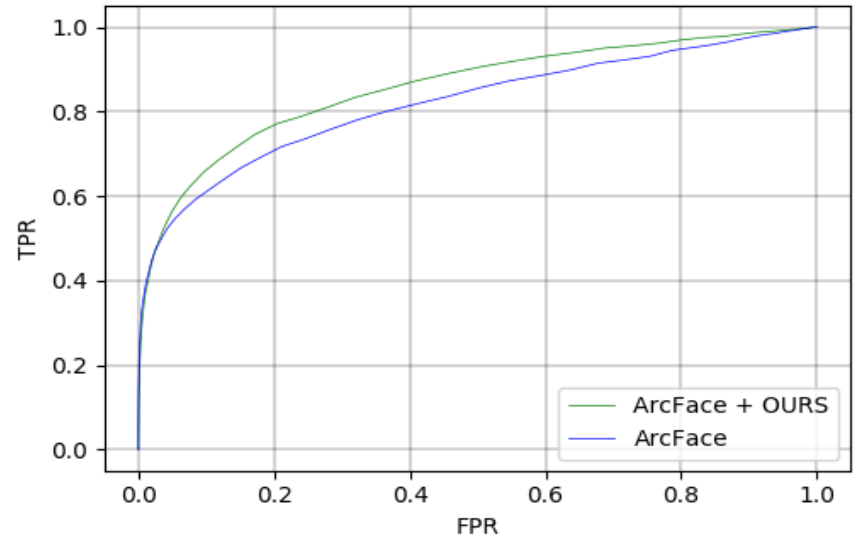
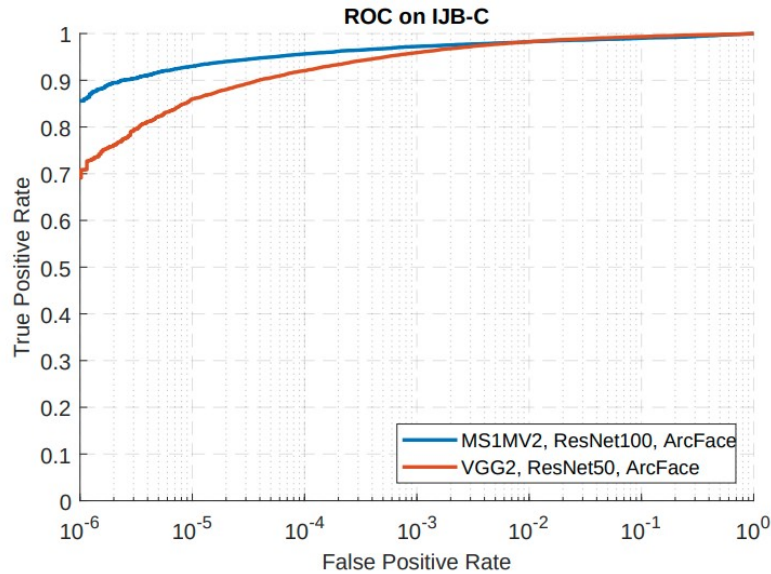

Image samples from **IJB-C**



Image samples from **SCFace**

Drawbacks of Previous Methods



ROC for ArcFace** on IJB-C

ROC for ArcFace on SCFace

** Jiankang Deng, Jia Guo, Niannan Xue, and Stefanos Zafeiriou, "Arcface: Additive angular margin loss for deep face recognition," in CVPR, 2019.

Drawbacks of Previous Methods

- Artifact or noise removal methods actually degrade FR/FD performance.
- Methods like IRCNN, ARCNN, IEGAN etc. doesn't improve FR/FD performance.
- We are looking for something that enhances FR/FD performance.

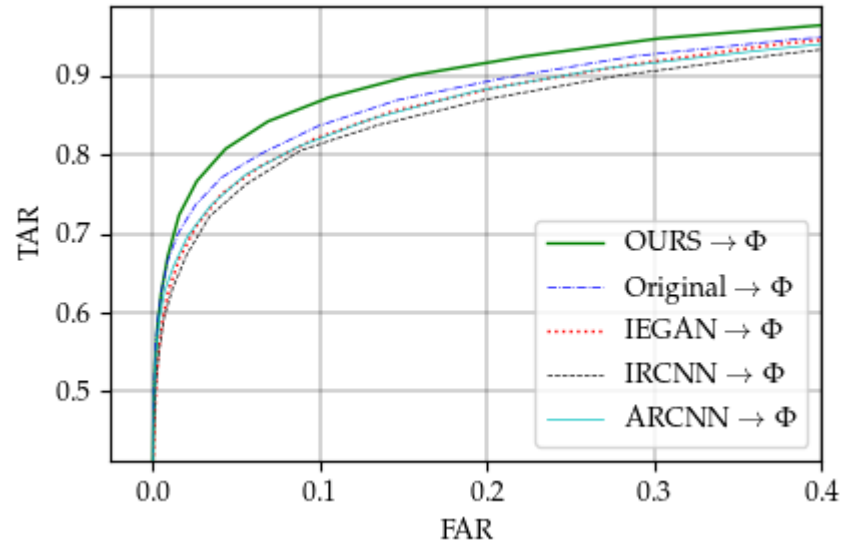

Aim of Research

- Develop a framework which can enhance the facial features of the images
- Develop a loss function which can better discriminate between images
- Improve face detection performance
- Improve face recognition performance

Achievements

- Proposed a constrained angular metric learning method that learns to discriminate facial features.
- Proposed an effective loss function to recover discriminative facial features.
- Improved detection rate by 3.08% compared to S3FD*.
- Improved recognition rate by 2.55% for ArcFace**.

* Shifeng Zhang, Xiangyu Zhu, Zhen Lei, Hailin Shi, Xiaobo Wang, and Stan Z. Li, "S3fd: Single shot scale-invariant face detector," in ICCV, 2017.

Network Architecture

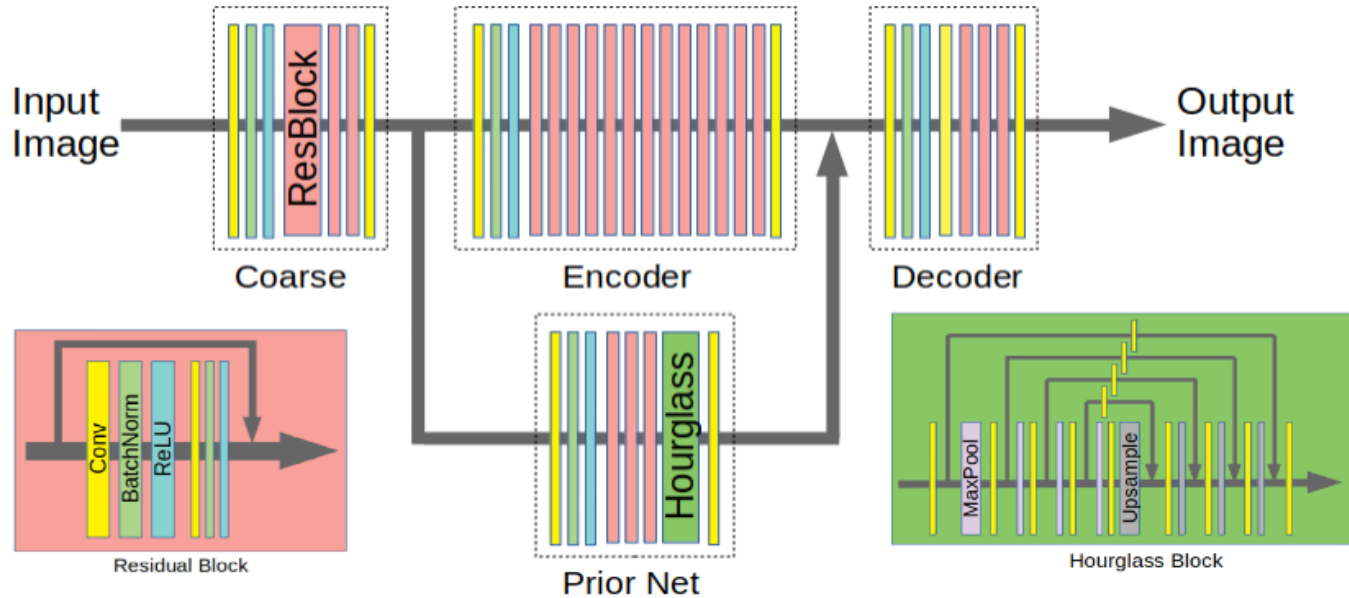

- Discriminator is in line with the architectural guidelines of DCGAN

Constrained Angular Metric Learning

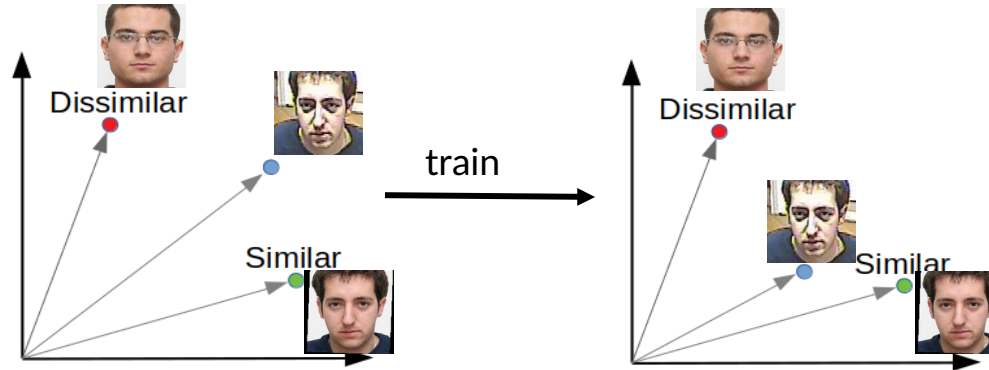

- There are two high quality anchors and they are fixed
 - The ground truth representative mugshot feature from the similar class
 - The ground truth representative mugshot feature from the dissimilar class

Loss Function

- Constrained Angular metric Loss
- Identity feature Loss
- Pixelwise Loss
- Perceptual Loss
- Discriminator loss

Loss function = Weighted sum of the above terms

Training Setup

- Network trained with ~**1.3M** images (128x128 pixels) of **14,528** identities.
- Images were aligned and cropped using MTCNN.
- Random degradations like MPEG/JPEG compression, changing brightness/contrast, interlacing artifacts, blurring etc. applied.
- Trained on Nvidia DGX Station.
- Implementation based on Tensorflow.

Face Detection Performance

Algorithm	dlib	SSD	MTCNN	S3FD
Original	90.35%	59.27%	91.96%	96.01%
ARCNN	87.38%	55.91%	90.94%	96.01%
IRCNN	87.66%	59.09%	90.56%	95.84%
IEGAN	89.02%	50.91%	87.76%	92.69%
Ours	95.31%	86.36%	95.36%	99.09%

Face Recognition Performance

Algorithm	TAR%@FAR				
	5%	1%	0.1%	0.01%	0.001%
ARCNN	77.39	62.25	50.62	38.39	29.72
IRCNN	75.78	61.29	47.41	33.64	21.15
IEGAN	76.82	63.09	48.82	34.71	20.21
Ours	82.06	67.90	51.01	39.19	33.35

Face Recognition Performance: ROC

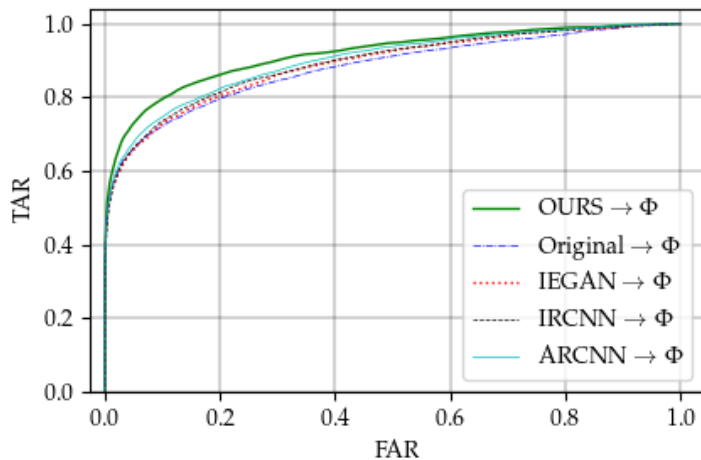

ArcFace

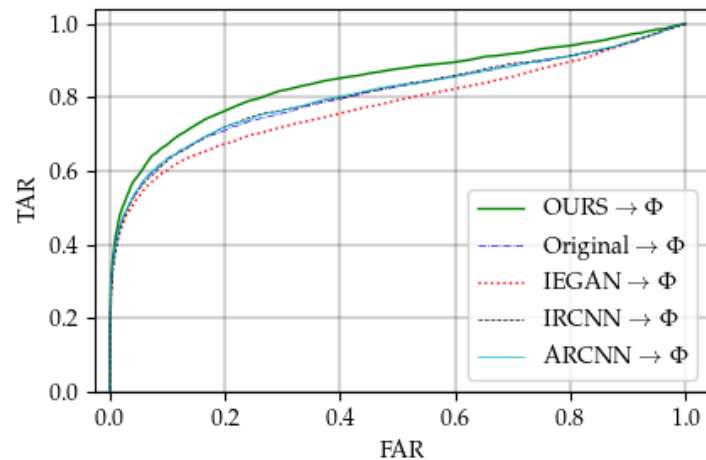

CosFace

Conclusion

- We presented a deep GAN for face enhancement that sets a improves detection and recognition of low-quality images
- This is done by targeting discriminative facial features.
- Improved perceptual quality does not guarantee improved recognition performance.
- This algorithm can be used in conjunction with any face recognition algorithm as a preprocessing step.